

SHELVING

ARTINOX

ECO LINE

Stainless steel
or powder-coated galvanised steel structure
Polypropylene shelves

Struttura in acciaio inox
o in acciaio zincato verniciato a polvere
Ripiani in polipropilene

Chromnickelstahl
oder verzinkte pulverbeschichtete Stahlstruktur
Polypropylen Fachböden

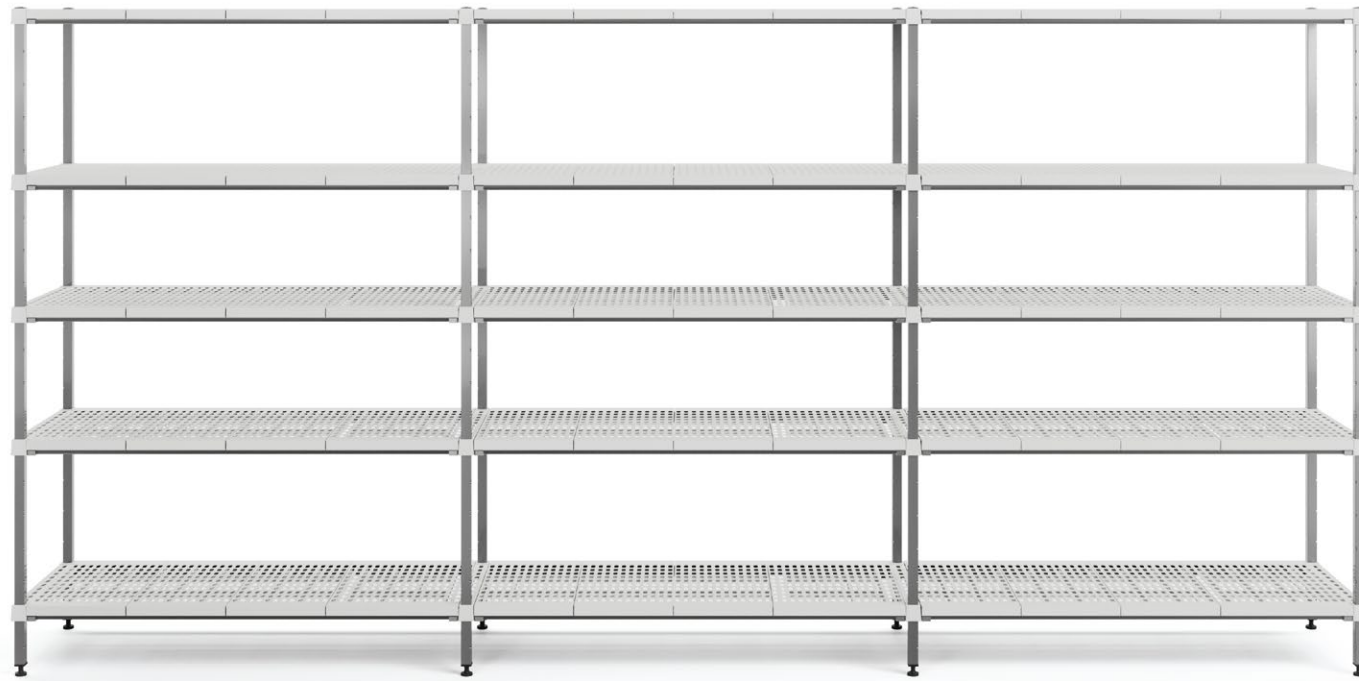

- **HYGIENIC**
- **STURDY**
- **VERSATILE**
- **RESISTANT UP TO -30°C**

- **IGIENICO**
- **ROBUSTO**
- **VERSATILE**
- **RESISTENTE FINO A -30°C**

- **HYGIENISCH**
- **ROBUST**
- **VIELSEITIG**
- **BESTÄNDIG BIS -30°C**

Quick assembly

IN-FIX®, the patented self-locking fixing system, allows for easy and quick assembly, requiring only one operator, without the use of screws and tools.

Four types of depth bars for: starter shelving units [1], linear [2] or corner compositions [3] and compositions at 180° or 360° [4].

Height adjustable shelves on a 100 mm pitch.

Montaggio rapido

IN-FIX®, il sistema brevettato ad incastro conico autobloccante, consente un montaggio rapido con un solo operatore, senza viti e utensili.

Quattro tipi di traverse per: scaffalature singole [1], composizioni diritte [2] o ad angolo [3], composizioni a 180° o 360° [4].

Ripiani regolabili in altezza, con passo 100 mm.

Schnelle Montage

IN-FIX®, das patentierte selbstblockierende Befestigungssystem, erlaubt eine schnelle und praktische Montage, die ohne Schrauben und Werkzeug durchgeführt werden kann.

Vier Typen Tiefequerbalken für: Grundregale [1], Gerade [2] oder Übereck Kompositionen [3] und 180° oder 360° Kompositionen [4].

Höhenverstellbare Fachböden im 100 mm Raster.

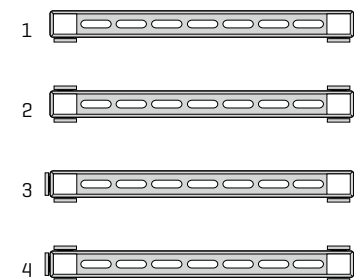

INOX LINE

Stainless steel uprights
Stainless steel shelves

Montanti in acciaio inox
Ripiani in acciaio inox

Chromnickelstahl Regalständer
Chromnickelstahl Fachböden

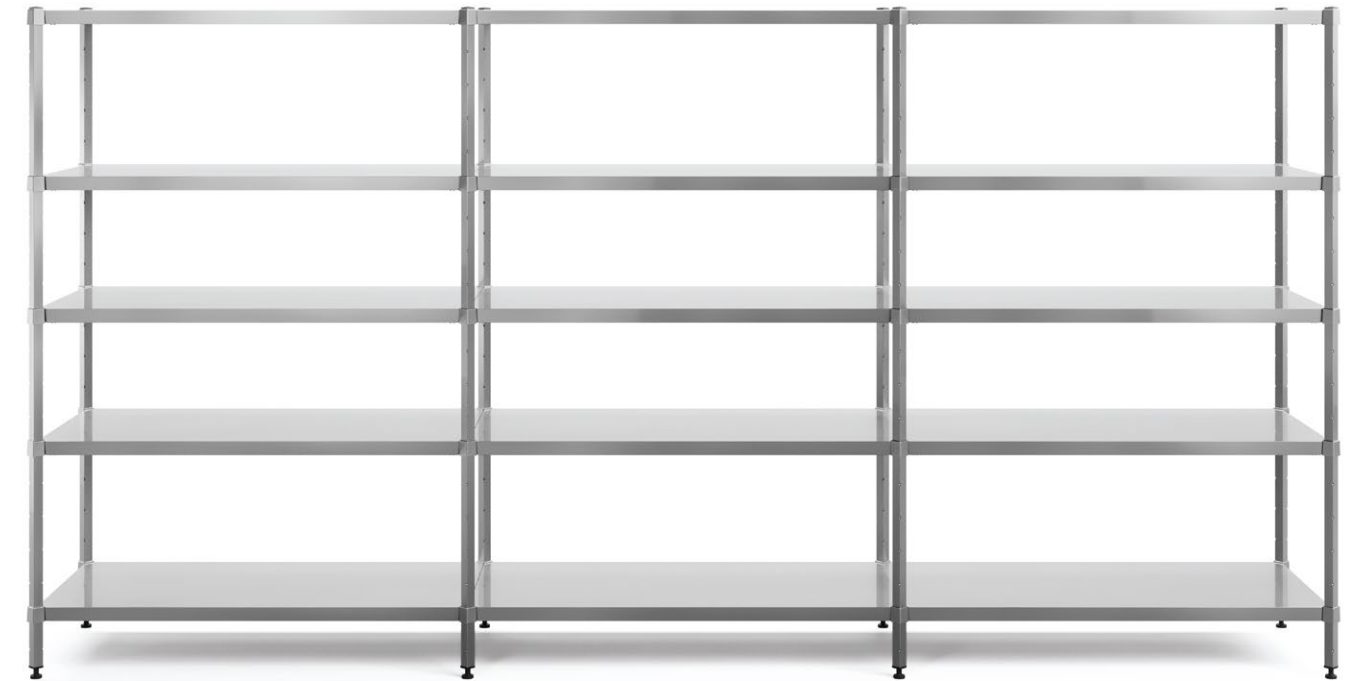

- **HYGIENIC**
- **STURDY**
- **VERSATILE**
- **RESISTANT UP TO -40°C**

- **IGIENICO**
- **ROBUSTO**
- **VERSATILE**
- **RESISTENTE FINO A -40°C**

- **HYGIENISCH**
- **ROBUST**
- **VIELSEITIG**
- **BESTÄNDIG BIS -40°C**

Quick assembly

IN-FIX®, the patented self-locking fixing system, allows for easy and quick assembly, requiring only one operator, without the use of screws and tools.

Four types of fixing components for: starter shelving units [1], linear [2] or corner compositions [3] and compositions at 180° or 360° [4].

Height adjustable shelves on a 100 mm pitch.

Montaggio rapido

IN-FIX®, il sistema brevettato ad incastro conico autobloccante, consente un montaggio rapido con un solo operatore, senza viti e utensili.

Quattro tipi di aggancio per: scaffalature singole [1], composizioni diritte [2] o ad angolo [3], composizioni a 180° o 360° [4].

Ripiani regolabili in altezza con passo 100 mm.

Schnelle Montage

IN-FIX®, das patentierte selbstblockierende Befestigungssystem, erlaubt eine schnelle und praktische Montage, die ohne Schrauben und Werkzeug durchgeführt werden kann.

Vier Halterung Typen für: Grundregale [1], Gerade [2] oder Übereck Kompositionen [3] und 180° oder 360° Kompositionen [4].

Höhenverstellbare Fachböden im 100 mm Raster.

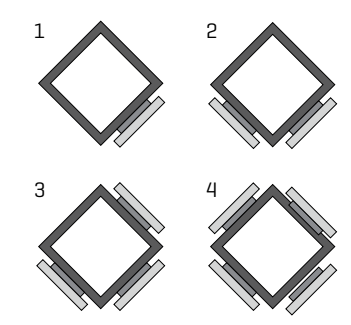

INOX STANDARD



STRUCTURE / STRUTTURA / STRUKTUR

Material / Materiale / Material:
AISI 304 stainless steel
uprights and fixing components /
Montanti e agganci
in acciaio inox AISI 304 /
Regalständer und Halterungen
aus Chromnickelstahl W 1.4301

**Tube section / Sezione tubo /
Rohrabschnitt (mm):**
30 X 30 X 1

Heights / Altezze / Höhen (mm):
1400 - 1600 - 1800 - 2000

SHELVES / RIPIANI / FACHBÖDEN

Material / Materiale / Material:
AISI 304 stainless steel /
Acciaio inox AISI 304/
Chromnickelstahl W 1.4301

Thickness / Spessore / Dicke (mm):
40

Lengths / Lunghezze / Längen (mm):
600 - 700 - 800 - 900 - 1000
1100 - 1200 - 1300 - 1400 - 1500
1600 - 1700 - 1800 - 1900 - 2000

Depths / Profondità / Tiefen (mm):
300 - 400 - 500 - 600

SHELF TYPES / TIPI DI RIPIANO / FACHBÖDEN TYPEN

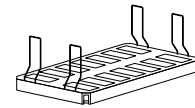
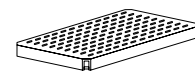
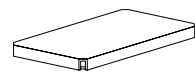

Smooth shelves
Ripiani lisci
Glatte Fachböden

Perforated shelves
Ripiani forati
Gelochte Fachböden

Bottle shelves
Ripiani portabottiglie
Flaschen-Fachböden

LOAD CAPACITY / CAPACITÀ DI CARICO / TRAGFÄHIGKEIT

Shelf length / Lunghezza ripiano / Regalbreiten	Kg*
600 > 1000 mm	200
1100 > 1500 mm	150
1600 > 2000 mm	100

*
Load capacity per shelf with evenly distributed weight
Portate per ripiano con distribuzione uniforme del carico
Tragfähigkeit pro Boden bei gleichmäßiger Verteilung der Last

Total load / Carico totale / Gesamtbelastung:

MAX 800 KG

ACCESSORIES AND COMPLEMENTS / ACCESSORI E COMPLEMENTI / ZUBEHÖRTEILE UND KOMPLEMENTE

- Fixing components to floor, ceiling, wall
Fissaggi a pavimento, soffitto, muro
Boden-, Decken-, Wandbefestigungen
- Stainless steel back panels
Lamiera di tamponamento in acciaio inox
Rückwände aus Chromnickelstahl
- Stainless steel anti-roll bars
Barre anti-rollo in acciaio inox
Antirollstangen aus Chromnickelstahl
- Load distribution plates
Piastrine di distribuzione peso al suolo
Bodendruckverteilungsplatten
- Stainless steel swivelling castors
Ruote girevoli in acciaio inox
Drehbare Räder aus Chromnickelstahl

INOX PLUS



STRUCTURE / STRUTTURA / STRUKTUR

Material / Materiale / Material:
AISI 304 stainless steel
uprights and fixing components /
Montanti e agganci
in acciaio inox AISI 304 /
Regalständer und Halterungen
aus Chromnickelstahl W 1.4301

**Tube section / Sezione tubo /
Rohrabschnitt (mm):**
40 X 40 X 1.2

Heights / Altezze / Höhen (mm):
1400 - 1600 - 1800 - 2000

SHELVES / RIPIANI / FACHBÖDEN

Material / Materiale / Material:
AISI 304 stainless steel /
Acciaio inox AISI 304/
Chromnickelstahl W 1.4301

Thickness / Spessore / Dicke (mm):
50

Lengths / Lunghezze / Längen (mm):
600 - 700 - 800 - 900 - 1000
1100 - 1200 - 1300 - 1400 - 1500
1600 - 1700 - 1800 - 1900 - 2000

Depths / Profondità / Tiefen (mm):
300 - 400 - 500 - 600

SHELF TYPES / TIPI DI RIPIANO / FACHBÖDEN TYPEN

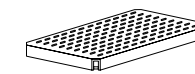
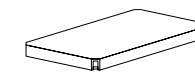

Smooth shelves
Ripiani lisci
Glatte Fachböden

Perforated shelves
Ripiani forati
Gelochte Fachböden

LOAD CAPACITY / CAPACITÀ DI CARICO / TRAGFÄHIGKEIT

Shelf length / Lunghezza ripiano / Regalbreiten	Kg*
600 > 1000 mm	350
1100 > 1500 mm	300
1600 > 2000 mm	200

*
Load capacity per shelf with evenly distributed weight
Portate per ripiano con distribuzione uniforme del carico
Tragfähigkeit pro Boden bei gleichmäßiger Verteilung der Last

Total load / Carico totale / Gesamtbelastung:

MAX 1200 KG

ACCESSORIES AND COMPLEMENTS / ACCESSORI E COMPLEMENTI / ZUBEHÖRTEILE UND KOMPLEMENTE

- Fixing components to floor, ceiling, wall
Fissaggi a pavimento, soffitto, muro
Boden-, Decken-, Wandbefestigungen
- Stainless steel back panels
Lamiera di tamponamento in acciaio inox
Rückwände aus Chromnickelstahl
- Stainless steel anti-roll bars
Barre anti-rollo in acciaio inox
Antirollstangen aus Chromnickelstahl
- Load distribution plates
Piastrine di distribuzione peso al suolo
Bodendruckverteilungsplatten
- Stainless steel swivelling castors
Ruote girevoli in acciaio inox
Drehbare Räder aus Chromnickelstahl

ECO INOX



STRUCTURE / STRUTTURA / STRUKTUR

Materials / Materiali / Materialien:

AISI 304 stainless steel structure, polypropylene depth bars /
Struttura in acciaio inox AISI 304, traverse in polipropilene /
Chromnickelstahl W 1.4301 Struktur, Polypropylen Tiefequerbalken

Tube section / Sezione tubo / Rohrschnitt (mm):

30 X 30 X 1

Depths / Profondità / Tiefen (mm):

300 - 400 - 500 - 600

Heights / Altezze / Höhen (mm):

1400 - 1600 - 1800 - 2000

SHELVES / RIPIANI / FACHBÖDEN

Materials / Materiali / Materialien:

Polypropylene or AISI 304 stainless steel /
Polipropilene o acciaio inox AISI 304 /
Polypropylen oder Chromnickelstahl W 1.4301

Thickness / Spessore / Dicke (mm):

40

Lengths / Lunghezze / Längen (mm):

600 - 700 - 800 - 900 - 1000

1100 - 1200 - 1300 - 1400 - 1500

1600 - 1700 - 1800 - 1900 - 2000

Depths / Profondità / Tiefen (mm):

300 - 400 - 500 - 600

SHELF TYPES / TIPI DI RIPIANO / FACHBÖDEN TYPEN

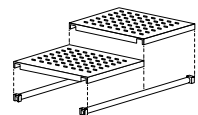

Dishwasher safe polypropylene shelves

Ripiani in polipropilene lavabili in lavastoviglie

Spülmaschinenfest Polypropylen Fachböden

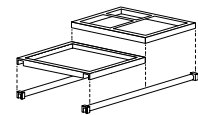

Stainless steel holders for GN containers

Supporti in acciaio inox per contenitori GN

Chromnickelstahl Halter für GN Behälter

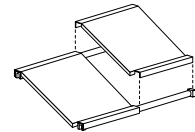

Stainless steel inclined shelves

Ripiani inclinati in acciaio inox

Chromnickelstahl Schrägböden

LOAD CAPACITY / CAPACITÀ DI CARICO / TRAGFÄHIGKEIT

Shelf length / Lunghezza ripiano / Regalbreiten	Kg*
600 > 1000 mm	250
1100 > 1500 mm	200
1600 > 2000 mm	150

* Load capacity per shelf with evenly distributed weight
Portate per ripiano con distribuzione uniforme del carico
Tragfähigkeit pro Boden bei gleichmäßiger Verteilung der Last

Total load / Carico totale / Gesamtbelastung:

MAX 1000 KG

ACCESSORIES AND COMPLEMENTS / ACCESSORI E COMPLEMENTI / ZUBEHÖRTEILE UND KOMPLEMENTE

- Fixing components to floor, ceiling, wall
Fissaggi a pavimento, soffitto, muro
Boden-, Decken-, Wandbefestigungen
- Stainless steel back panels
Lamiera di tamponamento in acciaio inox
Rückwände aus Chromnickelstahl
- Stainless steel anti-roll bars
Barre anti-rollo in acciaio inox
Antirollstangen aus Chromnickelstahl
- Load distribution plates
Piastrine di distribuzione peso al suolo
Bodendruckverteilungsplatten
- Stainless steel swivelling castors
Ruote girevoli in acciaio inox
Drehbare Räder aus Chromnickelstahl
- Meat hangers and platforms
Ganciere e pedane
Fleischgehänge und Bodenröste

ECO COLOR



STRUCTURE / STRUTTURA / STRUKTUR

Materials / Materiali / Materialien:

Powder-coated galvanized steel structure, polypropylene depth bars /
Struttura in acciaio zincato verniciato a polvere, traversi in polipropilene /
Verzinkte pulverbeschichtete Stahlstruktur, Polypropylen Tiefequerbalken

Tube section / Sezione tubo / Rohrschnitt (mm):

30 X 30 X 1

Depths / Profondità / Tiefen (mm):

300 - 400 - 500 - 600

Heights / Altezze / Höhen (mm):

1400 - 1600 - 1800 - 2000

SHELVES / RIPIANI / FACHBÖDEN

Material / Materiale / Material:

Polypropylene / Polipropilene / Polypropylen

Thickness / Spessore / Dicke (mm):

40

Lengths / Lunghezze / Längen (mm):

600 - 700 - 800 - 900 - 1000

1100 - 1200 - 1300 - 1400 - 1500

1600 - 1700 - 1800 - 1900 - 2000

Depths / Profondità / Tiefen (mm):

300 - 400 - 500 - 600

SHELF TYPES / TIPI DI RIPIANO / FACHBÖDEN TYPEN

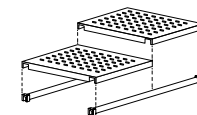

Dishwasher safe polypropylene shelves

Ripiani in polipropilene lavabili in lavastoviglie

Spülmaschinenfest Polypropylen Fachböden

LOAD CAPACITY / CAPACITÀ DI CARICO / TRAGFÄHIGKEIT

Shelf length / Lunghezza ripiano / Regalbreiten	Kg*
600 > 1000 mm	250
1100 > 1500 mm	200
1600 > 2000 mm	150

* Load capacity per shelf with evenly distributed weight
Portate per ripiano con distribuzione uniforme del carico
Tragfähigkeit pro Boden bei gleichmäßiger Verteilung der Last

Total load / Carico totale / Gesamtbelastung:

MAX 1000 KG

ACCESSORIES AND COMPLEMENTS / ACCESSORI E COMPLEMENTI / ZUBEHÖRTEILE UND KOMPLEMENTE

- Fixing components to floor, ceiling, wall
Fissaggi a pavimento, soffitto, muro
Boden-, Decken-, Wandbefestigungen
- Load distribution plates
Piastrine di distribuzione peso al suolo
Bodendruckverteilungsplatten
- Stainless steel swivelling castors
Ruote girevoli in acciaio inox
Drehbare Räder aus Chromnickelstahl

ARTINOX SHELVING

Ideal for horeca, retail, agri-food, hospital, chemical, pharmaceutical and naval sectors.

SCAFFALATURE ARTINOX

Ideali per i settori horeca, gdo, agroalimentare, ospedaliero, chimico, farmaceutico e navale.

ARTINOX-REGALE

Speziell geeignet für Horeca, Supermarkt, Lebensmittel-, Chemie-, Pharma - und Schiffbau-Bereichen.

ARTINOX spa

Via F. Fabbrì, 39 - z.i. Campidui
 31015 Conegliano (Treviso) - Italy
 Tel. +39 0438 4531 - Fax +39 0438 453200
 commerciale@artinox.com
 www.artinox.com



Our products are eco friendly
 with 100% recyclable materials.

I nostri prodotti rispettano l'ambiente
 con materiali riciclabili al 100%.

Unsere Produkte sind umweltfreundlich
 mit Materialien zu 100 % rezyklierbar.



The NF "Hygiène Alimentaire" mark, issued by ANFOR Certification, certifies the compliance with the NF031 specific rules, available on www.marque-nf.com, for the cleaning aptitude.